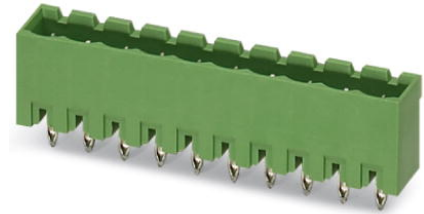

## EMSTBVA 2,5/ 8-G-5,08

Order No.: 1859577

The figure shows a 10-position version of the product

<http://eshop.phoenixcontact.de/phoenix/treeViewClick.do?UID=1859577>Header, nominal current: 12 A, rated voltage: 200 V, pitch: 5.08 mm,  
no. of positions: 8, mounting: press in

### Commercial data

EAN	4017918132996
Pack	50 Pcs.
Customs tariff	85366990
Weight/Piece	0.00372 KG
Catalog page information	Page 217 (CC-2007)

### Product notes

WEEE/RoHS-compliant since:  
01/01/2003

<http://www.download.phoenixcontact.com>  
Please note that the data given here has been taken from the online catalog. For comprehensive information and data, please refer to the user documentation. The General Terms and Conditions of Use apply to Internet downloads.

### Technical data

#### Dimensions / positions

Pitch	5.08 mm
Dimension a	35.56 mm
Number of positions	8
Pin dimensions	1,7 mm
Hole diameter	1.75 mm

#### Technical data

Insulating material group	IIIa
Rated surge voltage (III/3)	4 kV
Rated surge voltage (III/2)	4 kV
Rated surge voltage (II/2)	4 kV
Rated voltage (III/2)	320 V
Rated voltage (II/2)	320 V
Connection in acc. with standard	EN-VDE
Nominal current $I_N$	12 A
Nominal voltage $U_N$	200 V
Maximum load current	12 A
Insulating material	PBT
Inflammability class acc. to UL 94	V0

#### Certificates / Approvals



#### CUL

Nominal voltage $U_N$	300 V
Nominal current $I_N$	10 A

#### UL

Nominal voltage $U_N$	300 V
Nominal current $I_N$	10 A
Certification	CB, CUL, GOST, UL, VDE-PZI

#### Accessories

Item	Designation	Description
------	-------------	-------------

#### Assembly

1877203	EMSTB 2,5-SH	Stamp holder, for upper and lower stamp
1877229	EMSTBVA 2,5-SS-2-5,08	Stamp set, consisting of an upper and lower stamp, upper stamp: 17 to 24-pos., lower stamp: 2 to 24-pos., pitch: 5.08 mm
1755477	MSTB-BL	Keying cap, for forming sections, plugs onto header pin, green insulating material

**Marking**

0804293	SK 5,08/3,8:FORTL.ZAHLEN	Marker card, printed horizontally, self-adhesive, 12 identical decades marked 1-10, 11-20 etc. up to 91-(99)100, sufficient for 120 terminal blocks
---------	--------------------------	---

**Plug/Adapter**

1734401	CR-MSTB	Coding section, inserted into the recess in the header or the inverted plug, red insulating material
---------	---------	--

**Additional products**

Item	Designation	Description
<b>General</b>		
1872758	A-ICV 2,5/ 8-G-5,08	Header, nominal current: 12 A, rated voltage: 250 V, pitch: 5.08 mm, no. of positions: 8, mounting: Mounting rail
1873113	FKC 2,5/ 8-ST-5,08	Plug component, nominal current: 12 A, rated voltage: 250 V, pitch: 5.08 mm, no. of positions: 8, type of connection: Spring-cage connection
1902178	FKCT 2,5/ 8-ST-5,08	Plug component, nominal current: 12 A, rated voltage: 250 V, pitch: 5.08 mm, no. of positions: 8, type of connection: Spring-cage connection
1874015	FKCVR 2,5/ 8-ST-5,08	Plug component, nominal current: 12 A, rated voltage: 250 V, pitch: 5.08 mm, no. of positions: 8, type of connection: Spring-cage connection
1873715	FKCVW 2,5/ 8-ST-5,08	Plug component, nominal current: 12 A, rated voltage: 250 V, pitch: 5.08 mm, no. of positions: 8, type of connection: Spring-cage connection
1777345	FRONT-MSTB 2,5/ 8-ST-5,08	Plug component, nominal current: 12 A, rated voltage: 250 V, pitch: 5.08 mm, no. of positions: 8, type of connection: Screw connection
1786462	IC 2,5/ 8-G-5,08	Header, nominal current: 12 A, rated voltage: 320 V, pitch: 5.08 mm, number of positions: 8, mounting type: soldering
1786006	ICV 2,5/ 8-G-5,08	Header, nominal current: 12 A, rated voltage: 320 V, pitch: 5.08 mm, number of positions: 8, mounting type: soldering
1757077	MSTB 2,5/ 8-ST-5,08	Plug component, nominal current: 12 A, rated voltage: 250 V, pitch: 5.08 mm, no. of positions: 8, type of connection: Screw connection
1764235	MSTB 2,5/ 8-STZ-5,08	Plug component, nominal current: 12 A, rated voltage: 250 V, pitch: 5.08 mm, no. of positions: 8, type of connection: Screw connection
1808874	MSTBC 2,5/ 8-ST-5,08	Plug component, nominal current: 12 A, rated voltage: 320 V, pitch: 5.08 mm, no. of positions: 8, type of connection: Crimp connection

1809569	MSTBC 2,5/ 8-STZ-5,08	Plug component, nominal current: 12 A, rated voltage: 320 V, pitch: 5.08 mm, no. of positions: 8, type of connection: Crimp connection
1769078	MSTBP 2,5/ 8-ST-5,08	Plug component, nominal current: 12 A, rated voltage: 250 V, pitch: 5.08 mm, no. of positions: 8, type of connection: Screw connection
1781043	MSTBT 2,5/ 8-ST-5,08	Plug component, nominal current: 12 A, rated voltage: 250 V, pitch: 5.08 mm, no. of positions: 8, type of connection: Screw connection
1824188	MSTBU 2,5/ 8-STD-5,08	Plug component, nominal current: 12 A, rated voltage: 320 V, pitch: 5.08 mm, no. of positions: 8, type of connection: Screw connection
1831375	MSTBVK 2,5/ 8-ST-5,08	Plug component, nominal current: 12 A, rated voltage: 320 V, pitch: 5.08 mm, no. of positions: 8, type of connection: Screw connection
1792304	MVSTBR 2,5/ 8-ST-5,08	Plug component, nominal current: 12 A, rated voltage: 250 V, pitch: 5.08 mm, no. of positions: 8, type of connection: Screw connection
1792812	MVSTBW 2,5/ 8-ST-5,08	Plug component, nominal current: 12 A, rated voltage: 250 V, pitch: 5.08 mm, no. of positions: 8, type of connection: Screw connection
1917969	QC 0,75/ 8-ST-5,08	Plug components, 5.08 mm pitch, color: green, no. of positions 8, dimension a 35.56 mm
1883310	QC 1/ 8-ST-5,08	Plug, nominal current: 10 A, rated voltage: 500 V, pitch: 5.08 mm, number of positions: 8, connection method: Insulation displacement connection QUICKON
1826348	SMSTB 2,5/ 8-ST-5,08	Plug component, nominal current: 12 A, rated voltage: 250 V, pitch: 5.08 mm, no. of positions: 8, type of connection: Screw connection
1853078	TMSTBP 2,5/ 8-ST-5,08	Plug component, nominal current: 12 A, rated voltage: 250 V, pitch: 5.08 mm, no. of positions: 8, type of connection: Screw connection
1833878	UMSTBVK 2,5/ 8-ST-5,08	Plug component, nominal current: 12 A, rated voltage: 320 V, pitch: 5.08 mm, no. of positions: 8, type of connection: Screw connection
1873029	ZFKK 1,5-ICV-5,08	Modular terminal blocks with plug entry, cross section: 0.2 - 1.5 mm <sup>2</sup> , width: 5.1 mm, color: gray

**Drawings**

Drilling diagram

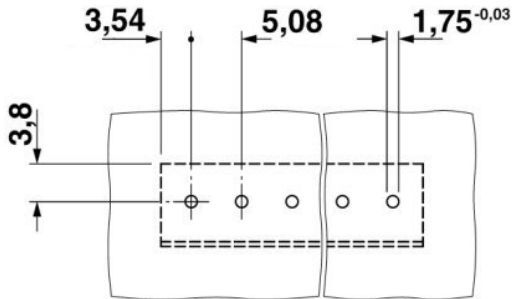

**Bore hole in the basic material,**  
 mostly epoxy glass fabric FR4 or EP-GC

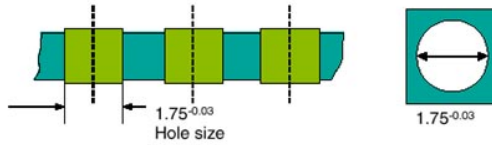

**Bore hole with Cu ferrule**

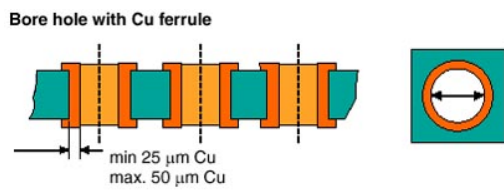

**Plated-through bore hole with Sn/SnPb**

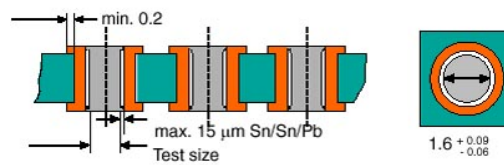

Dimensioned drawing

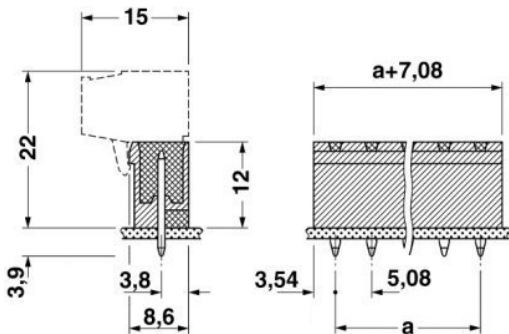

**Address**

PHOENIX CONTACT Inc., USA  
586 Fulling Mill Road  
Middletown, PA 17057, USA  
Phone (800) 888-7388  
Fax (717) 944-1625  
<http://www.phoenixcon.com>



© 2008 Phoenix Contact  
Technical modifications reserved;